

## **REPLACEMENT COMPONENTS (CONSUMABLES)**

Component	WLCP Part No.	Frequency of Replacement
Sediment Filter	22-1835	Every 6 Months
Carbon Pre-Filter	22-1840	Every 6 Months
RO Membrane Filter	22-1845	Every 6 Months
Carbon Post Filter	22-1850	Every 6 Months
Hot Tank Assembly	22-1660	Every 5 Years depending on use

**⚠ CAUTION!** Use only Waterlogic Replacement parts that can be obtained from *Waterlogic* or an *Authorized Waterlogic Dealer*, failure to do so will void the Warranty.

See Installation and Service Manual for additional information.

### **Hot Tank Service**

Hot Tanks (with controls) must be replaced every 5 years.

### **Surface Cleaning**

Clean on a regular basis with damp lint free cloth. Never use harsh chemicals (alcohol or acid based) or abrasive agents on any part of the product to avoid damage. A mild cleaner such as Simple Green or equivalent is recommended.

### **Tank Sanitization**

Clean and sanitize the inside of the ambient tank, ice bin, and cold tank on an annual basis to inhibit issues with biofilm and mold. This process is covered in the Installation section.

## **DISPOSAL**

### **End of Life**

At the **end of this product's life**, ensure that it is disposed of in an environmentally friendly manner which is fully compliant **with all Federal/State/Local Requirements and Guidelines**. Do not dispose of this appliance with normal household or business waste.

## WL900 MAIN DRAWING AND PARTS LIST



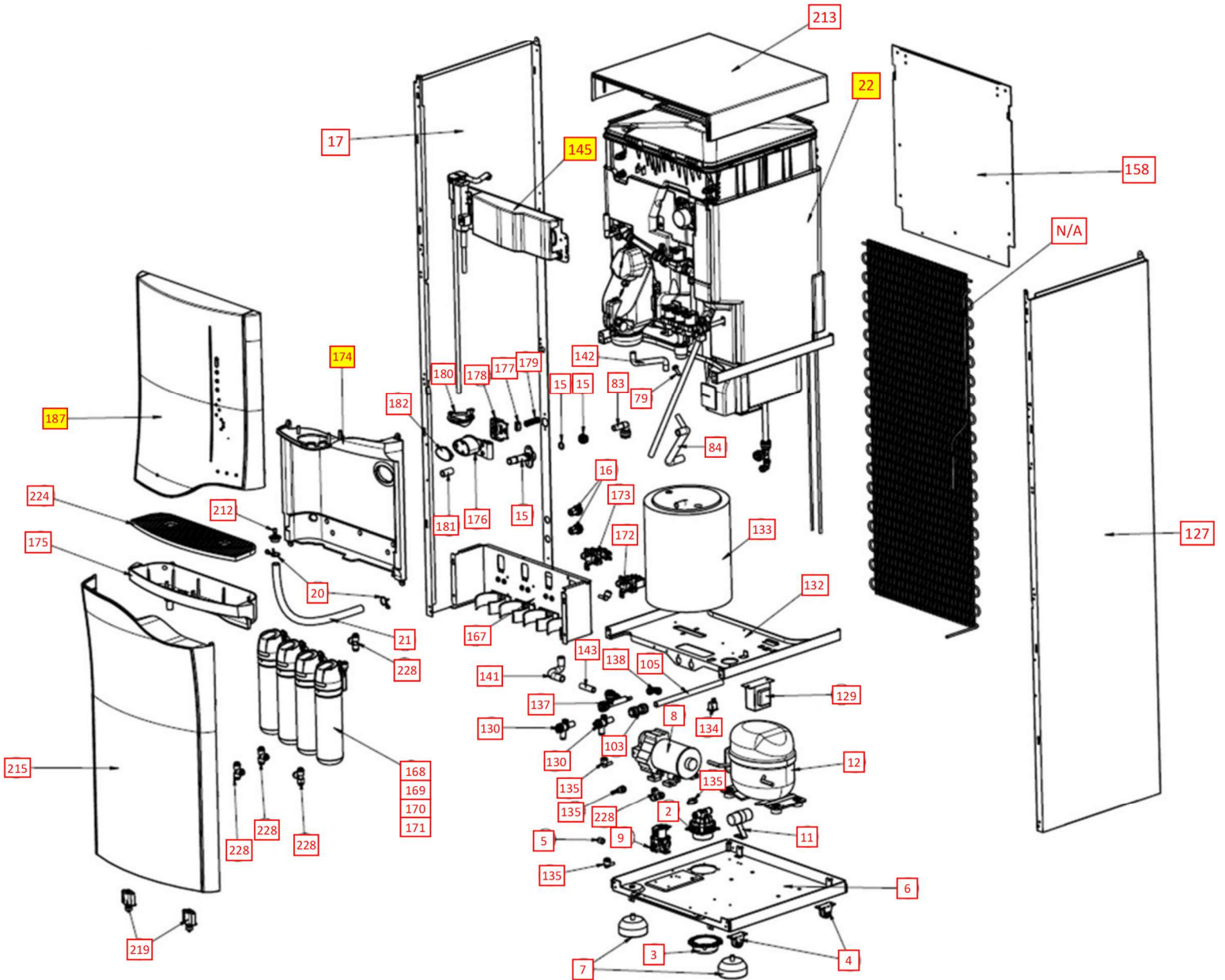



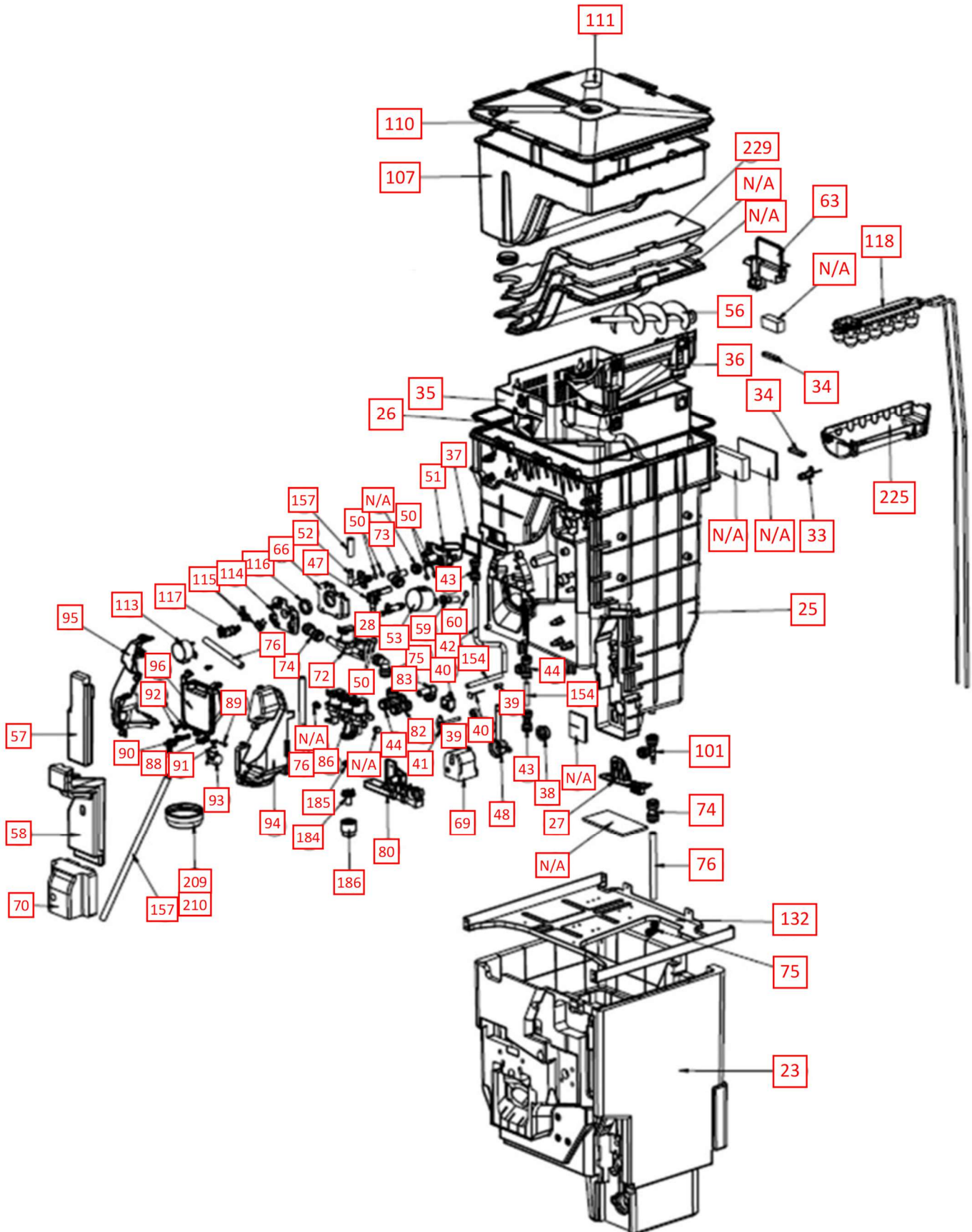



Yellow = Consumables
Green = Recommended spare parts



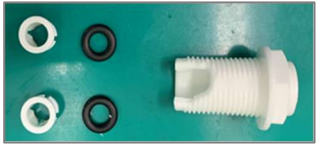







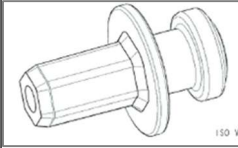

## WL900 ICE UNIT DRAWING AND PARTS LIST

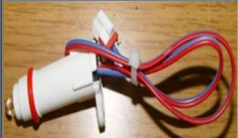

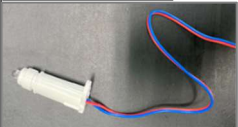
No	WLCP Part No.	Description	Part No	Purchase as:	
1	22-1000	Base Panel Assembly	91-2250-0	Assembly	
2	22-1005	FM Valve 1/4"PTC	11-1624-1	Individually	
3	22-1010	Gutter FM Valve	11-1346-0	Assembly	
4	22-1015	Caster	21-0313-0	Assembly	
5	22-1020	Tube End 3/8"	31-0867-0	Assembly	
6	22-1025	Base Panel	21-0403-4	Assembly	
7	22-1030	Leg: Nob-less	11-0351-0	Assembly	
8	22-1035	Booster Pump	41-1494-1	Individually	
9	22-1040	Solenoid V/V: Raw Water	41-0789-3	Individually	
10	22-1045	Wire AC #3 with Fuse and Fuse Holder	41-2030-0	Individually	
11	22-1050	Fixed Clip: Capacitor	25-0056-1	Individually	

12	22-1055	Compressor : Samsung MSA670C-D1G	41-1828-1	Individually	
13	22-1060	Refrigerant Step Valve	41-1607-1	Individually	
14	22-1065	Left Side Panel Assy	91-3415-0	Assembly	
15	22-1070	Drain Connector Assy	11-2467-0	Assembly	
16	22-1075	Bulk Head 1/4" PTC	11-0297-0	Assembly	
17	22-1080	Left Side Panel	21-0717-1	Assembly	
18	22-1085	Ball Valve 1/4" PTC	11-0527-0	Assembly	
19	22-1090	Drain Tube Assy PVC	91-2696-0	Assembly	
20	22-1095	Spring Clip 17mm Diameter	21-0521-0	Assembly	
21	22-1100	Tube PVC	77-1188-0	Assembly	
22	22-1105	Ice Unit Assembly	91-2783-0	Assembly	
23	22-1110	Unit Panel	21-0709-0	Assembly	Not Shown

24	22-1115	Hook Ice Basket	11-2216-0	Assembly	
25	22-1120	Ice Unit	11-2468-1	Assembly	
26	22-1125	Seal Unit	31-0932-0	Assembly	
27	22-1130	Bushing Spiral	11-2991-0	Assembly	
28	22-1135	Sensor: Ice Full Transmit	41-0524-1	Assembly	
29	22-1140	O-Ring P10A	31-0327-0	Assembly	
30	22-1145	Ice Full Transmitter	11-0631-1	Assembly	
31	22-1150	Sensor: Ice Full Receive	41-1810-0	Assembly	
32	22-1155	O-Ring P10A	31-0327-0	Assembly	
33	22-1160	Ice Full Receiver	11-0630-0	Assembly	
34	22-1165	Rubber Bracket EVA	31-0934-0	Individually	

35	22-1170	Ice Basket	11-2470-1	Individually	
36	22-1175	Ice Separator	11-2471-1	Individually	
37	22-1180	Distributor Gasket	31-0885-0	Individually	
38	22-1185	Head Pump Circulator Seal	31-0324-1	Individually	
39	22-1190	Cold Sensor Seal	31-0035-1	Individually	
40	22-1195	Cold Water Level Sensor	41-1795-0	Individually	
41	22-1200	Cold Water Temp Sensor	41-1801-0	Individually	
42	22-1205	Pipe Assy SUS 3/8"	91-2763-0	Assembly	
43	22-1210	Straight PTC Fitting 3/8	11-0434-0	Assembly	
44	22-1215	Tee Fitting 3/8"	11-0435-0	Assembly	
45	22-1220	O-ring P9	31-0329-0	Assembly	

46	22-1225	Pipe SUS 3/8"	21-0713-2	Assembly	
47	22-1230	Pipe Bucket In	11-2493-1	Assembly	
48	22-1235	Circulation Pump Head	11-2224-0	Assembly	
49	22-1240	Water Distributor Assembly	91-2764-0	Assembly	
50	22-1245	O-Ring P8	31-0328-0	Assembly	
51	22-1250	Distributor	91-2546-0	Assembly	
52	22-1255	Connector Elbow	11-2215-1	Assembly	
53	41-1911-1	Ice Discharge Motor	41-1911-0	Individually	
55	22-1270 (Obsolete) See line 230	Auger Bushing Connector SUS	11-2931-0	Individually	
56	22-1275 (Obsolete) See line 230	Spiral Auger	21-0839-2	Individually	
57	22-1280	EPS Upper Unit	61-1475-0	Individually	









58	22-1285	EPS Lower Unit	61-1476-1	Individually	
59	22-1290SS (Obsolete) See line 230	Auger Motor Coupler SS	21-1061-0	Individually	
60	22-1295	O-Ring AN012	31-0880-0	Individually	
61	22-1300	Rubber Bracket EVA	31-0934-0	Individually	
62	22-1305	Rear Bracket Assy EVA	91-2765-0	Assembly	
63	22-1310	Rear Bracket EVA	11-2487-0	Assembly	
64	22-1315	Rubber Bracket EVA	31-0934-0	Assembly	
65	22-1320	Ice Tray Rotational Coupler	11-2220-2	Individually	
66	22-1325	EPS Motor Panel	61-1782-0	Individually	
67	22-1330	Motor Link Gasket	31-0881-0	Individually	
68	22-1335	O-Ring P22	31-0581-0	Individually	

69	22-1340	Ice Circulation Pump	41-2022-0	Individually	
70	22-1345	Circulation Pump EPS	61-1477-0	Individually	
71	22-1350	Solenoid V/V: 3way Water Supply Assembly	91-2679-0	Individually	
72	22-1355	Sol V/V: 3way Filter Water Supply	41-1800-0	Individually	
73	22-1360	Elbow Fitting 1/2"S-1/2"PTC	14-0085-0	Individually	
74	22-1365	Straight Fitting 1/2"PTC	72-0029-0	Individually	
75	22-1370	Elbow Fitting 1/2"PTC	11-0424-0	Individually	
76	22-1375	Tubing 1/2" LLDPE	77-1194-0	Individually	
77	22-1380	PE Tube Insulation	31-0939-0	Individually	
78	22-1385	Solenoid V/V: 3way Dispense Assembly	91-2767-0	Individually	

79	22-1390	Fitting End Plug 1/4"	11-0431-0	Individually	
80	22-1395	Bracket Solenoid Valve 3way	11-2488-0	Individually	
81	22-1400	Fitting Tee 1/2"PTC	11-2532-0	Individually	
82	22-1405	Fitting Reducer 3/8"-1/2"PTC	11-2533-0	Individually	
83	22-1410	Stem Fitting Elbow 1/2" PTC	14-0085-0	Individually	
84	22-1415	Hot Tube 2way	31-0928-0	Individually	
85	22-1420	DC Wire #2	41-1797-0	Individually	
86	22-1425	Solenoid Valve for 3way Dispense	41-1799-0	Individually	
87	22-1430	Ice Chute Assembly	91-2760-0	Assembly	
88	22-1435	Link-Arm: Ice Door	11-2478-0	Assembly	

89	22-1440	Link-Arm Door Pin	11-2210-0	Assembly	
90	22-1445	Link-Arm: Motor	11-2477-0	Assembly	
91	22-1450	Link-Arm Middle Pin	11-2211-0	Assembly	
92	22-1455	E-Ring	21-0672-0	Assembly	
93	22-1460	Ice Door Motor	41-1285-0	Individually	
94	22-1465	Ice Chute Assembly Right Half	11-2491-0	Assembly	
95	22-1470	Ice Chute Assembly Left Half	11-2492-0	Assembly	
96	22-1475	Ice Chute Door	11-2204-1	Assembly	
97	22-1480	Ice Chute Door Cover	11-2205-0	Assembly	
98	22-1485	Ice Chute Door Outer Seal	31-0882-1	Assembly	
99	22-1490	Ice Chute Door Inner Seal	31-0883-1	Assembly	

100	22-1495	3way Connector Assembly	91-2681-0	Individually	
101	22-1500	3way Connector	11-2257-0	Individually	
102	22-1505	Elbow Fitting 1/4"PTC	11-1236-0	Individually	
103	22-1510	Straight Fitting 1/2"	72-0029-0	Individually	
104	22-1515	1/2" Tubing LLDPE	77-1198-0	Individually	
105	22-1520	1/2" Tubing LLDPE	77-1199-0	Individually	
106	22-1525	C/A Water Tank Assembly	91-2692-0	Assembly	
107	22-1530	Ambient Water Tank	11-2484-0	Individually	
108	22-1535	Lid Gasket Ambient Water Tank	31-0890-1	Individually	
109	22-1540	Ambient Tank Cover Assembly	91-2761-0	Assembly	
110	22-1545	Ambient Tank Cover	11-2469-0	Assembly	
111	22-1550	Medium Filter	51-0137-1	Assembly	

112	22-1555	Ice Tray Motor Assembly	91-2915-0	Individually	
113	22-1560	Ice Tray Stepping Motor	41-1624-0	Individually	
114	22-1565	Ice Tray Motor Bracket	11-2226-1	Individually	
115	22-1570	Wire DC #5	41-1613-3	Individually	
116	22-1575	O-Ring P9	31-0329-0	Individually	
117	22-1580	Rotational Coupler	11-2203-2	Individually	
118	22-1585	Ice Evaporator	21-0705-1	Assembly	
119	22-1590	Ice Temperature Sensor	41-0648-0	Assembly	
120	22-1595	Lower Heater Bracket	21-0440-4	Assembly	
121	22-1600	EVA Bracket Upper	21-0669-1	Assembly	

122	22-1605	Cover Unit Middle-Upper	11-2485-1	Individually	
123	22-1610	Right Side Panel Assembly	91-3393-0	Assembly	
124	22-1615	Cord Bushing	77-0049-0	Assembly	
125	22-1620	Insulated Pad PE	31-0153-0	Assembly	Not shown
126	22-1625	Power Cord Plug B	41-2020-0	Assembly	
127	22-1630	Right Side Panel	21-0718-1	Assembly	
128	22-1635	Hot Tank Panel Assembly	91-3392-0	Individually	
129	22-1640	Transformer	41-2018-0	Individually	
130	22-1645	Drain Valve 1/2"	11-2219-0	Individually	
131	22-1650	Hot Tank Wire	41-0138-0	Individually	
132	22-1655	Hot Tank Panel	21-0710-0	Individually	

133	22-1660	Hot Tank Assy (Tank, Sensor, Bi-metals)	91-3376-0	Individually	
134	22-1665	Drainage Switch	41-1119-0	Individually	
135	22-1670	Straight Fitting 1/4"PTC	11-1323-0	Individually	
136	22-1675	Hot Water Cleaning Fitting Assembly	91-2226-0	Individually	
137	22-1680	4way Connector	11-2258-0	Individually	
138	22-1685	Elbow Fitting 1/4"	11-1236-0	Individually	
139	22-1690	Elbow Stem Fitting 1/2"S-1/2"PTC	14-0085-0	Individually	
140	22-1695	Elbow Fitting 1/4"	11-0422-0	Individually	
141	22-1700	Hot Tank Tube Drain	31-0929-0	Individually	
142	22-1705	Hot Outlet Tube	31-0824-0	Individually	

143	22-1710	1/2" Tubing LLDPE	77-1200-0	Individually	
144	22-1715	Bimetal Thermostat/Overload	41-0366-1	Individually	
145	22-1720	PCB Main Panel Assembly	91-3394-0	Individually	
146	22-1725	Panel—Main PCB	21-0408-2	Individually	
147	41-2368-2	Water Level Detection Sensor	41-2368-2	Individually	
148	22-1735	PCB Holder	77-0526-0	Individually	
149	22-1740	Main PCB—CHP-5440S	41-1910-0	Individually	
150	22-1745	Straight Tube 30mm	31-0979-0	Individually	
151	22-1750	Hot Tank Air Gap Assembly	91-2766-0	Individually	
152	22-1755	Hot Tank Air Gap	11-2482-0	Assembly	
153	22-1760	Hot Tank Air Gap Cover	11-2483-0	Assembly	



154	22-1765	Straight Tube 3/8"	31-0377-0	Assembly	
155	22-1770	Air Vent Tube	31-0930-0	Assembly	
156	22-1775	Tank Seal	31-0935-0	Assembly	
157	22-1780	3/8" Tubing PE-RT	77-1192-0	Assembly	
158	22-1785	Rear Panel	21-0407-3	Individually	
159	22-1790	Wire DC #4	41-1612-0	Individually	
160	22-1795	Wire DC #13	41-1614-0	Individually	
161	22-1800	Wire DC #2	41-1347-0	Individually	Not Shown
162	22-1805	Wire Solenoid Valve bank to PCB	41-1796-1	Individually	
163	22-1810	Surrounding Temperature Sensor	41-1446-1	Individually	
164	22-1815	5-Slot Filter Head Assembly	91-3397-0	Individually	
165	22-1820	Filter Clip	11-0125-2	Individually	

166	11-0758-0	Filter Hanger	11-0758-0	Individually	
167	22-1830	Filter Bracket	21-0406-3	Individually	
168	ICESED	Sediment Filter	51-9096-0	Individually	
169	ICEPREC	Carbon Pre-Filter	51-9097-0	Individually	
170	ICERO	RO Filter	51-9099-1	Individually	
171	ICEPOSTCA	Carbon Post-Filter	51-9098-0	Individually	
172	22-1855	Drain S/V (Low Pressure)	41-1147-1	Individually	
173	22-1860	Solenoid Valve: AFV	41-0500-1	Individually	
174	22-1865	Front Middle Assembly	91-3417-0	Assembly	
175	22-1870	Drip Tray	11-0756-1	Assembly	
176	22-1875	Push Button	11-0806-2	Assembly	

177	22-1880	Wire #6-4 + Dispense Toggle Switch	41-0606-0	Assembly	
178	22-1885	Push Button Cover	11-1481-1	Assembly	
179	22-1890	Spring	21-0417-0	Assembly	
180	22-1895	Decorative Faucet (Ice)	11-2049-0	Assembly	
181	22-1900	3/8" Tube End	31-0867-0	Assembly	
182	22-1905	Rubber Dispense Button	31-0330-0	Assembly	
183	22-1910	Front Middle	11-0754-6	Assembly	
184	22-1915	Manifold Faucet	11-2494-0	Individually	
185	22-1920	Gasket Inner Faucet	31-0931-0	Individually	
186	22-1925	Decorative Faucet (Water)	11-1574-1	Individually	

187	22-1930	Front Upper Assy—WL Logo	91-3384-0	Assembly	
188	22-1935	Front Upper Panel	11-2499-0	Assembly	
189	22-1940	UBS Rubber Plug	31-0556-0	Assembly	
190	22-1945	LED Window—Full	11-0772-1	Assembly	
191	22-1950	LED Window—Lock	11-0773-1	Assembly	
192	22-1955	LED Window—Constant	11-0774-1	Assembly	
193	22-1960	LED Window—Dispense	11-0775-1	Assembly	
194	22-1965	LED Window—Ice	11-0776-1	Assembly	
195	22-1970	LED Window—Bar	11-0771-0	Assembly	
196	22-1975	PCB Ice Dispense	41-1794-1	Assembly	
197	22-1980	PCB Selection Cover	11-0777-0	Assembly	

198	22-1985	PCB-USB	41-0715-0	Assembly	
199	22-1990	PCB Dispense Selection Key	41-1793-1	Assembly	
200	22-1995	PCB Window Bar	41-1791-0	Assembly	
201	22-2000	Wire PCB Main- LED	41-0512-1	Assembly	
202	22-2005	PCB Selection/Continual Dispense	41-1792-0	Assembly	
203	22-2010	Cover Dispenser PCB	11-0779-0	Assembly	
204	22-2015	Wire DC #7	41-0643-0	Assembly	
205	22-2020	Wire DC #8	41-0644-0	Assembly	
206	22-2025	Wire DC #9	41-0645-0	Assembly	
207	22-2030	Wire DC #11	41-0646-1	Assembly	
208	22-2035	Main PCB Cover	21-0838-0	Individually	

209	22-2040	Decorative Dispenser Ring	11-0540-0	Individually	
210	22-2045	Decorative Dispenser Cap	31-0712-0	Individually	
211	22-2050	1/2" Tube End	31-0025-1	Individually	
212	22-2055	Tray Cap	11-1169-3	Individually	
213	11-0755-0	Top Cover	11-0755-0	Individually	
214	91-2631-0	Front Lower Assembly	91-2631-0	Assembly	
215	22-2070	Front Lower Panel (Blk)	11-0753-2	Assembly	
216	22-2075	Front Lower Panel Shaft Pin	11-0182-1	Assembly	
217	22-2080	Shaft Pin Spring	21-0216-0	Assembly	
218	22-2085	E-Ring (C-clip)	78-0090-0	Assembly	
219	22-2090	Shaft Pin Holder Assy	91-0055-0	Assembly	

220	22-2095	Shaft Holder Housing	11-0199-0	Assembly	
221	22-2100	Shaft Pin Spring	21-0216-0	Assembly	
222	22-2105	E-ring (C-clip)	78-0090-0	Assembly	
223	22-2110	Front Lower Shaft Pin	11-0182-1	Assembly	
224	22-2115	Tray Grill	11-0757-1	Individually	
225	22-2120	Ice Water Bucket (Ice Tray)	11-2220-1	Individually	
226	22-2125	Hot Tank Thermistor (Incl. w/ Hot Tank Assy)	41-1446-1	Individually	
227	22-2130	Hot Tank Thermistor Silicone Block (Incl. w/ Hot Tank Assy.)	N/A	Individually	
228	22-1432	Ice Door Assembly (Door and Seals)	N/A	Individually	
229	22-1457	Link Arm Assembly (with both pins and clips)	N/A	Individually	
230	91-5567-0	Auger/SS Coupler/Conn. Assy – WL900	91-5567-0	Assembly	